

DACS inc.

MATERIAL HANDLING

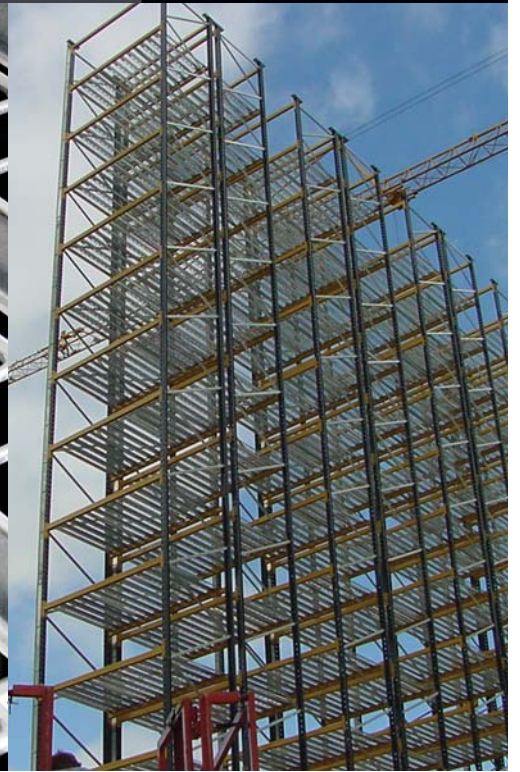

PUNCH DECK[®]

OPEN AREA RACK DECK

www.punchdeck.com

PUNCH DECK®

FEATURES & BENEFITS:

- **Fire Protection** - Large openings (50% open area for common rack sizes) allow sprinkler water through to lower levels.
- **Product Friendly** - Punch Deck's smooth top surface reduces product hang-ups that can cause damage.
- **Ergonomically Designed** - Hand stacked boxes slide on and off easily without catching.
- **Uniform Strength** - Punch Deck's repeating corrugations provide uniform strength across the entire shelf and minimize local surface distortions.
- **No Waterfall Edge** - Punch Deck is flush with the top of the step beam allowing for easy labeling and bar coding on the face of the beam.
- **Freight Savings** - Up to 3 times more square footage of Punch Deck can be shipped on a single truck than most other deck products.
- **Attractive Look** - Bright galvanized finish gives your warehouse a sleek clean look that is easy to maintain.
- **Pricing** - Punch Deck is priced competitively with other decking products.
- **Short Lead Times** - Most standard sizes are available for quick shipments. Check with DACS for specific project lead times.

- **Typical Storage Applications**

- Office Records
- Furniture (*both pallet & cantilever rack*)
- Mattresses
- Carpeting and Flooring
- Garments
- Small Boxes
- Rolled Fabrics & Cloth
- Building Components
- Auto Parts
- Bagged Goods

Punch Deck's open surface area allows sprinkler water through to lower levels.

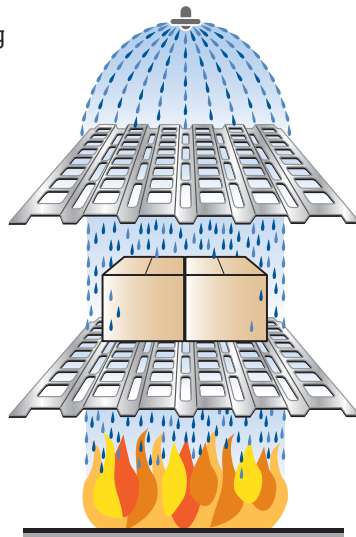

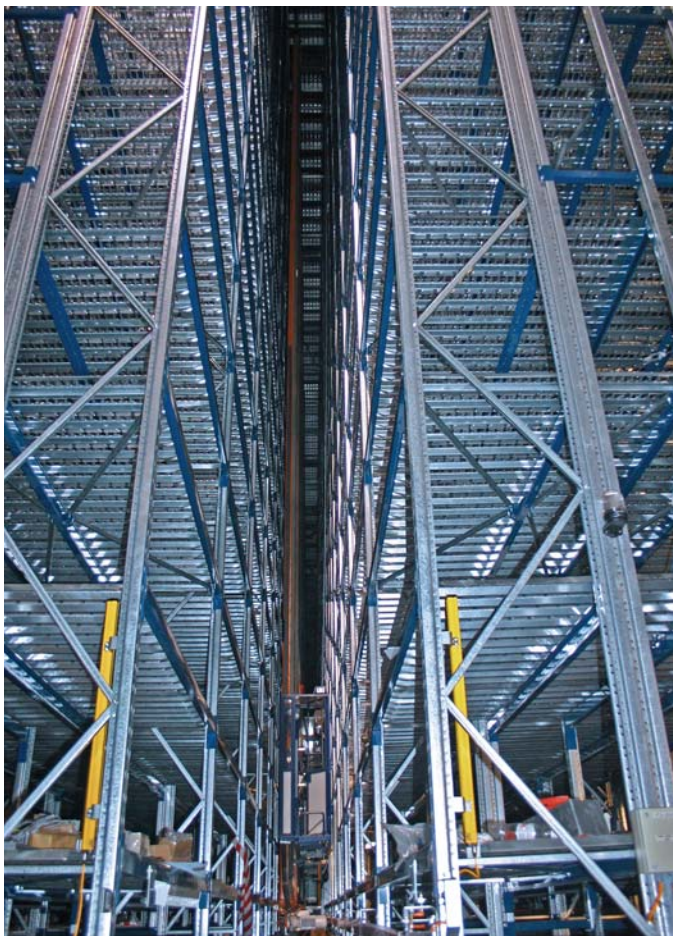

PUNCH DECK LOAD TABLES

English	Rack Depth - lb/sq. ft.							
	36"	42"	48"	50"	54"	60"	66"	72"
Punch Deck® 101	200	135	91	80	64			
Punch Deck® 201	225	194	130	115	91	70	50	
Punch Deck® 301	250	200	178	158	125	92	70	50

Metric	Rack Depth - kg/sq. m.							
	915mm	1065	1220	1270	1370	1525	1676	1830
Punch Deck® 101	978	660	445	391	313			
Punch Deck® 201	1100	949	636	562	445	342	245	
Punch Deck® 301	1223	978	870	773	611	450	342	245

Capacities are based on uniform distribution, span/180 maximum deflection and 24 KSI maximum steel stress.

AVAILABLE WIDTHS

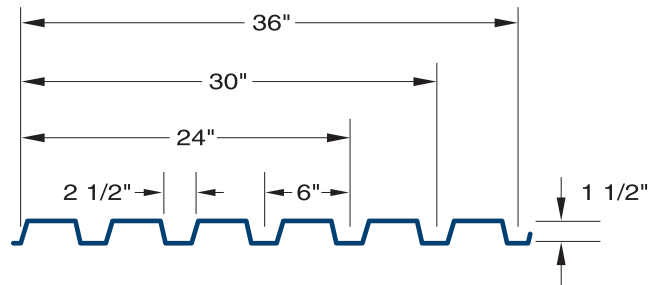

Combine to achieve desired rack shelf coverage.

Examples: 96" = 2@30" + 1@36"

108" = 3@36"

144" = 4@36"



PUNCH DECK INSTALLATION RECOMMENDATIONS

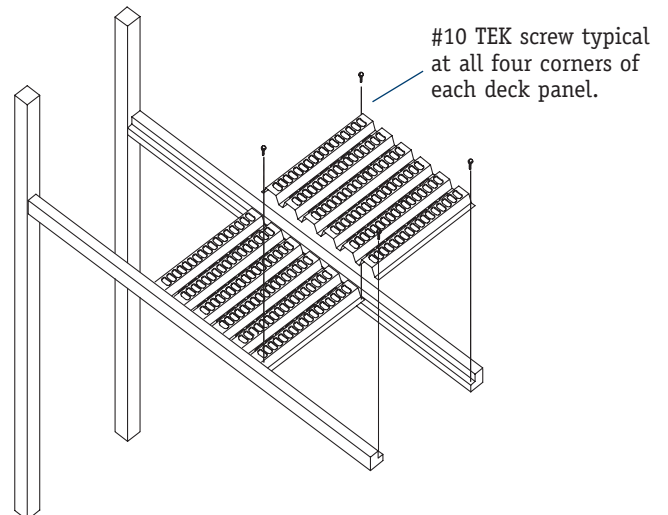

Step 1 - Place 1st panel into step beams at far left side of shelf. Position panel so required transverse flue space is maintained between left edge of panel and shelf in adjacent rack bay.

Step 2 - Tek screw 2 left hand corners of 1st panel into step beam.

Step 3 - Position remaining deck panels into step beam, overlapping as required at joints.

Step 4 - Tek screw remaining panels into beam through overlapping joints and at 2 right hand corners.

PUNCH DECK®



ACCESSORIES



SHELF DIVIDERS

Wire dividers for Punch Deck are available in both clip-on and hanging styles. PVC Pipe dividers are ideal for large, bulky items.



SOLID DECKING & FIRE BAFFLES

Available for rack deck, fire baffles, mezzanine deck and aisle sub-flooring in various heights, profiles, gauges and colors.

OPTIONS

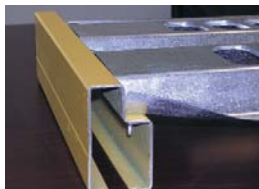

LOW PROFILE

Low Profile Punch Deck is specifically made to fit beams with a 1" step. (Bulk storage racks, European manufacturers)

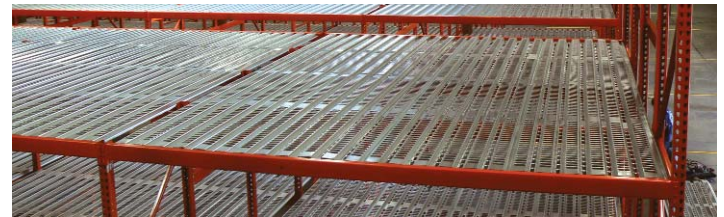

WIDE SPAN

Punch Deck is available in lengths up to 144" for oversize loads, double-deep racks and carpet racks.

OTHER PRODUCTS

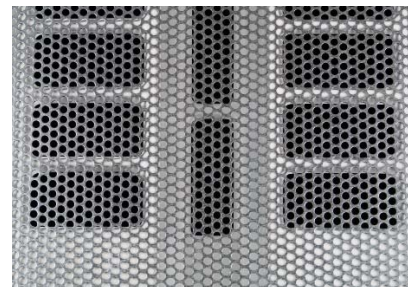

FlueKeeper® & FlueKeeper® HD

A simple, cost effective product to keep stored material out of rack transverse flue spaces - Fluekeeper provides 3" clearance between rack and stored material.

Original Fluekeeper's spring-loaded design and boltless front & rear connections make aisle-side installation easy.

Fluekeeper HD for palletized material - Heavy duty tube member is designed for up to 48" frames. Boltless front & rear connections make installation easy.

PUNCH DECK® PLUS

Punch Deck Plus is a unique solution for rack storage of furniture in a sprinklered warehouse environment. Its smooth, porous surface is ideal for items with legs or point loads (furniture, equipment with wheels, etc.) Galvanized finish is bright and maintenance free.



MATERIAL HANDLING



900 Port Centre Parkway, Portsmouth, VA 23704 USA
Toll-free: 866-400-8107 • Toll-free fax: 866-401-8107
+1-757-393-0704 • Fax: +1-757-393-9461
e-mail: sales@dacsinc.com

www.punchdeck.com

U.S. Patents: # 6,401,944 # 7,156,243 Canadian Patent # 2,421,323
Other U.S. & Foreign Patents Issued & Pending

© 2014 DACS, INC.